

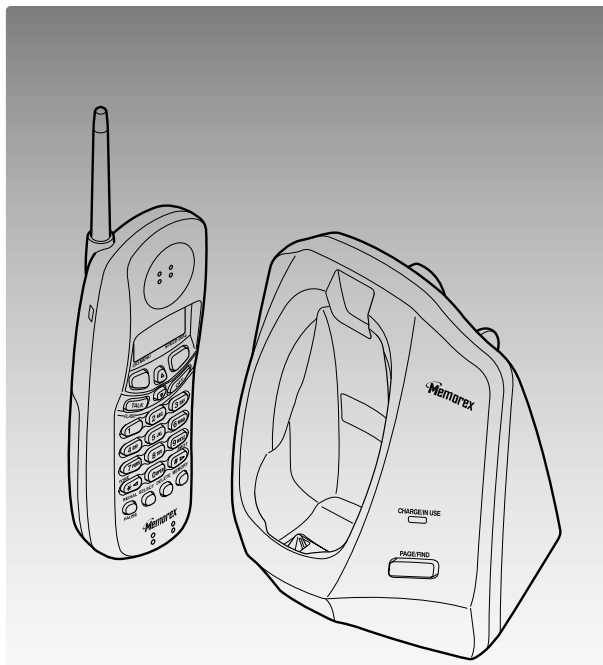

Cordless Telephone MPH6935

Owner's Manual



Thank you for your purchase of this cordless telephone. Please read this Owner's Manual carefully before using your cordless telephone to ensure proper use. After reading the manual, please keep it in a safe place and refer to it when necessary.

Introduction

Thank you for choosing this **Memorex®** cordless telephone. This phone is designed to exacting standards that provide reliability, long life and outstanding performance.

Note: Some illustrations in this manual may differ from the actual unit for explanation purposes.

Features

- 900 MHz Technology
- 3-line Backlit Display
- Face Up Charging
- 32 Digit Redial
- Page / Find
- Handset Earpiece and Ringer Volume Control
- Caller ID and Call Waiting Caller ID
- 30 Number Caller ID Memory
- 10 Memory Dial Locations
- Pulse / Tone Dialing
- 7 Hour Talk Time / 14 Day Standby Time
- Hearing Aid Compatible
- 20 Channel Autoscan
- Bilingual Language
- Speed Dial

This cordless telephone features include *Instant Talk* and *Auto Disconnect*. *Instant Talk* allows you to answer a call by just removing the handset from the base so you don't have to waste time pushing buttons. *Auto Disconnect* allows you to hang up by simply returning the handset to the base.

The *Mega Clear* true compander circuitry virtually eliminates background noise. This innovative technology provides you with the best possible reception during all your conversations.

To protect you against misbilled calls which might result from your phone being activated by other equipment, this cordless telephone has a digital security system which automatically selects one of approx. 260,000 digital security codes for the handset and base. Also, the *Mega Secure* feature electronically locks your phone when the handset is on the base.

To get the most from your phone, please read this owner's manual thoroughly. Also, be sure to complete and mail the product registration form.

Control and Functions

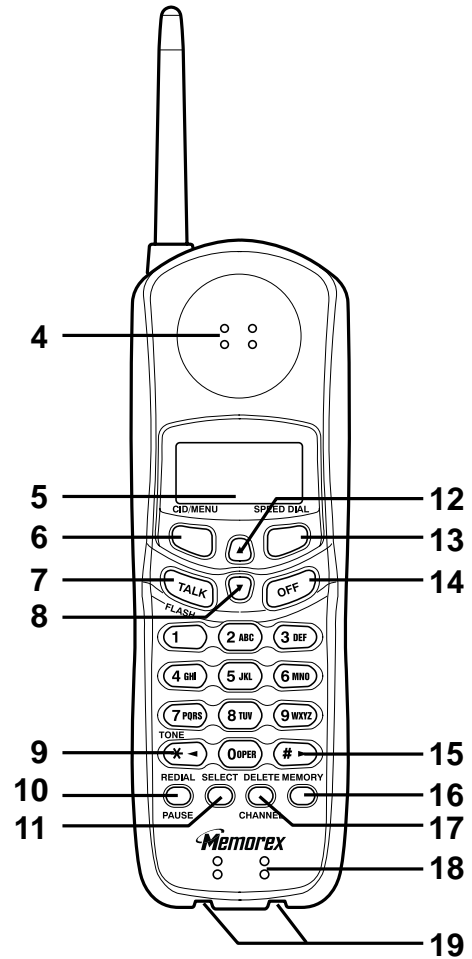
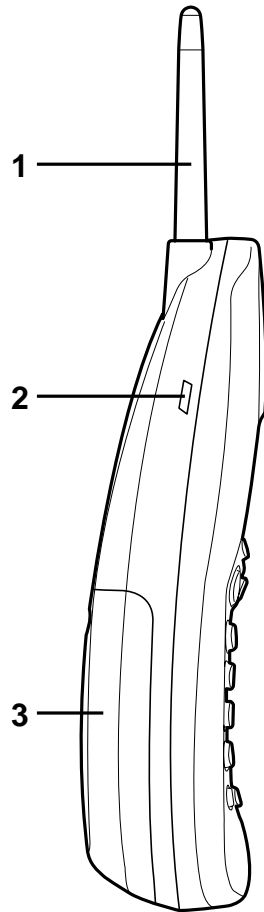

- 1. Handset antenna
- 2. Beltclip holes
- 3. Handset battery compartment

- 4. Handset earpiece
- 5. LCD display
- 6. Cid/Menu key
- 7. Talk/Flash key
- 8. Volume/Cursor down key
- 9. */Left cursor/Tone key
- 10. Redial/Pause key
- 11. Select key
- 12. Volume/Cursor up key
- 13. Speed Dial key
- 14. Off key
- 15. #/Right cursor key
- 16. Memory key
- 17. Delete/Channel key
- 18. Handset microphone
- 19. Battery charge contacts

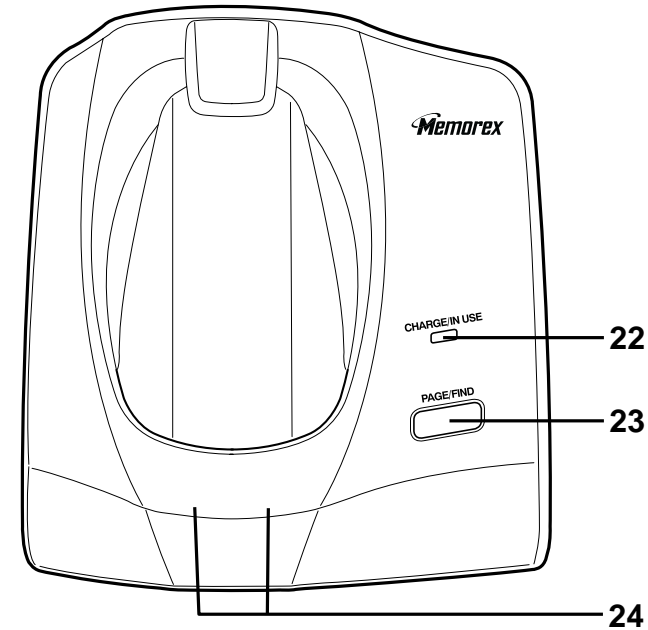
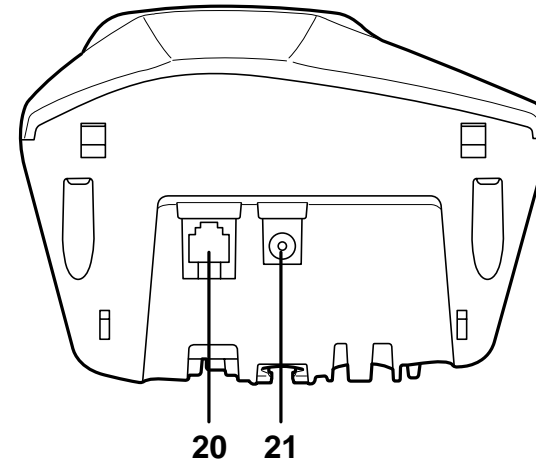

- 20. Phone jack
- 21. DC power input
- 22. Charge/In use LED
- 23. Page/Find key
- 24. Base contacts

Table of Contents

Introduction	1
Features	1
Control and functions	2
Important safety instructions	4
Important electrical considerations	6
Getting Started	
Read This First	8
Step 1: Checking the package contents.....	9
Step 2: Setting up the base unit.....	10
Step 3: Preparing the battery pack.....	13
Basics	
Making Calls	15
Dialing from standby.....	15
Dialing from talk mode.....	15
Redialing.....	15
Receiving Calls	16
Receiving a call.....	16
Handset Ringer and Earpiece Volume	17
Using The Page Feature	17
To locate the handset (while it's off the base).....	17
Telephone Features	
Memory Storing	18
Storing phone numbers and names.....	18
Steps for entering names and special characters.....	20
Memory Dialing	21
Making calls with memory dialing.....	21
Memory Editing	23
Editing a stored name and/or phone number.....	23
Memory Erasing	24
Erasing a stored name and phone number.....	24
Speed Dial Feature	25
Storing and Editing the Speed Dial.....	25
Making calls with speed dialing.....	25
Deleting the Speed Dial.....	25
Caller ID Features	
Caller ID.....	26
When the telephone rings.....	27
Viewing the Caller ID message list.....	28
Deleting information from the Caller ID list.....	29
Using the Caller ID list.....	30
Storing Caller ID messages in Memory.....	30
Using "Caller ID with Call Waiting" service.....	31
Additional Information	
Changing the digital security code.....	32
Mounting the base unit on a wall.....	33
Note on power sources.....	34
Maintenance.....	34
Troubleshooting.....	35
I.C. Notice.....	36
Index	37
Memorex Limited Warranty	38

Getting Started

Basics

Telephone
Features

Caller ID
Features

Additional
Information

Important safety instructions

When using your telephone equipment, these basic safety precautions should always be followed to reduce the risk of fire, electrical shock, and injury to persons:

1. Read and understand all instructions.
2. Follow all warnings and instructions marked on the product.
3. Unplug this product from the wall outlet before cleaning. Use a dry cloth for cleaning without liquid or aerosol cleaners.
4. Do not use this product near water; for example, near a bath tub, wash bowl, kitchen sink or laundry tub, in a wet basement, or near a swimming pool.
5. Do not place this product on an unstable cart, stand, or table. The telephone may fall, causing serious damage to the unit.
6. Slots and openings in the cabinet and the back or bottom are provided for ventilation. To protect the product from overheating, these openings must not be blocked or covered. This product should never be placed near or over a radiator or heat register. This product should not be placed in a built-in installation unless proper ventilation is provided.
7. This product should be operated only from the type of power source indicated on the marking label. If you are not sure of the type of power supply to your home, consult your dealer or local power company.
8. Do not allow anything to rest on the power cord. Do not locate this product where the cord will be damaged by persons walking on it.
9. Do not overload wall outlets and extension cords, as this can result in the risk of fire or electrical shock.
10. Never push objects of any kind into this product through cabinet slots, as they may touch dangerous voltage points or short out parts that could result in a risk of fire or electric shock. Never spill liquid of any kind on the product.
11. To reduce the risk of electric shock, do not disassemble this product. Take it to qualified service personnel when service or repair work is required. Opening or removing covers may expose you to dangerous voltages or other risks. Incorrect reassembly can cause electric shock when the appliance is subsequently used.
12. Unplug this product from the wall outlet and refer servicing to qualified service personnel under the following conditions:
 - A. When the power supply cord is damaged or frayed.
 - B. If liquid has been spilled into the product.
 - C. If the product has been exposed to rain or water.
 - D. If the product does not operate normally when following the operating instructions. (Adjust only those controls that are covered by the operating instructions. Improper adjustment of other controls may result in damage and will often require extensive repair work by a qualified technician.)

- E. If the product has been dropped or the cabinet has been damaged.
- F. If the product exhibits a distinct change in performance.

13. Do not use the telephone to report a gas leak in the vicinity of the leak.

Additional battery safety precautions

Caution: To reduce the risk of fire or injury to persons by the battery, read and follow these instructions:

1. Use only the appropriate type and size battery pack specified in the reference guide.
2. Do not dispose of the battery pack in a fire. The cell may explode.
3. Do not open or mutilate the battery pack. Released electrolyte is corrosive and may cause damage to the eyes or skin. It may be toxic if swallowed.
4. Exercise care in handling the battery in order not to short the battery with conducting materials such as rings, bracelets, and keys. The battery or conductor may overheat and cause burns.
5. Charge the battery pack provided with or identified for use with this product only in accordance with the instructions and limitations specified in the reference guide provided for this product.
6. Observe proper polarity orientation between the battery pack and battery charger.

Cordless telephone privacy

Note: Cordless telephones are radio devices. Communications between the handset and base of your cordless telephone are accomplished by means of radio waves which are broadcast over the open airways. Because of the inherent physical properties of radio waves, your communications can be received by radio receiving devices other than your own cordless telephone unit. Consequently, any communications using your cordless telephone may not be private.

Important electrical considerations

Unplug all electrical appliances when you know an electrical storm is approaching. Lightning can pass through your household wiring and damage any device connected to it. This phone is no exception.

Warning: Please do not attempt to unplug any appliance during an electrical storm.

The FCC Wants You To Know

Changes or modifications to this product not expressly approved by the manufacturer, or operation of this product in any way other than as detailed by the reference guide, could void your authority to operate this product. The equipment cannot be used on public coin phone service provided by the telephone company. Connection to party line service is subject to state tariffs. (Contact the state public utility commission, public service commission or corporation commission for information.)

Range

Your new phone is designed to achieve the maximum possible range by transmitting and receiving according to the highest specifications set forth by the FCC. We have rated this phone to operate at a maximum distance with the qualification that the range depends upon the environment in which the telephone is used. Many factors limit range, and it would be impossible to include all the variables in our rating.

The Maximum Range rating of this phone is meant to be used as a means of comparison against other range claims.

Telephone Line Problems

The FCC has granted the telephone company the right to disconnect service in the event that your phone causes problems on the telephone line. Also, the telephone company may make changes in facilities and services which may affect the operation of your unit. However, your telephone company must give adequate notice in writing prior to such actions to allow you time for making necessary arrangements to continue uninterrupted service.

If you are having trouble with your telephone service, you must first disconnect your phone to determine if it is the cause of your problem. If you determine that it is the cause, you must leave it disconnected until the trouble has been corrected.

Radio Interference

Radio interference may occasionally cause buzzing and humming in your cordless handset, or clicking noises in the base. This interference is caused by an external source such as a TV, refrigerator, vacuum cleaner, fluorescent lighting, or electrical storm. Your unit is NOT DEFECTIVE. If these noises continue and are too distracting, please check around your home to see what appliances may be causing the problem. In addition, we recommend that the base not be plugged into a circuit that also powers a major appliance because of the potential for interference. Be certain the antenna is kept in the vertical position.

In the unlikely event that you consistently hear other voices or distracting transmissions on your phone, you may be receiving radio signals from another cordless telephone or other source of interference. If you cannot eliminate this type of interference, you need to change to a different channel.

Finally, it should be noted that some cordless telephones operate at frequencies that may cause interference to nearby TVs and VCRs. To minimize or prevent such interference, the base of the cordless telephone should not be placed near or on top of a TV or VCR. If interference is experienced, moving the cordless telephone farther away from the TV or VCR will often reduce or eliminate the interference.

More Than One Cordless Telephone

If you want to use more than one cordless telephone in your home, they must operate on different channels. Press the channel key to select a channel that provides the clearest communication.

Read This First

This cordless telephone must be set up before use. Follow these steps:

Step 1 (page 9)

Unpack the telephone and accessories.

Step 2 (page 10 to 12)

Next, choose the best location to set up the base unit.



Step 3 (page 13 to 14)

Then, insert the battery pack into the handset. You have to charge the battery pack for 15-20 hours before using the phone.



About the digital security code

This cordless telephone uses a digital security code to prevent unauthorized access to your base unit. This security code prevents other cordless handsets from making calls through your base unit.

A random security code will be assigned automatically between your base unit and handset when you charge the battery pack for the first time.

To reset the security code, see page 32.

Step 1

Checking the package contents

Make sure you have received the following items in the package.

- Base unit
- Handset
- Rechargeable battery pack (BT-905)
- Telephone line cord
- AC adapter (AD-310)
- This Owner's Manual
- Other Printed Materials

Important

Please keep all packaging material for at least 90 days in case you need to return this product to your place of purchase or Memorex.

Step 2

Setting up the base unit

Do the following steps:

- Choose the best location
- Connect the base unit
- Choose the dialing mode

Choose the best location

Before choosing a location for your new phone, read the IMPORTANT ELECTRICAL CONSIDERATIONS. Here are some important guidelines you should consider:

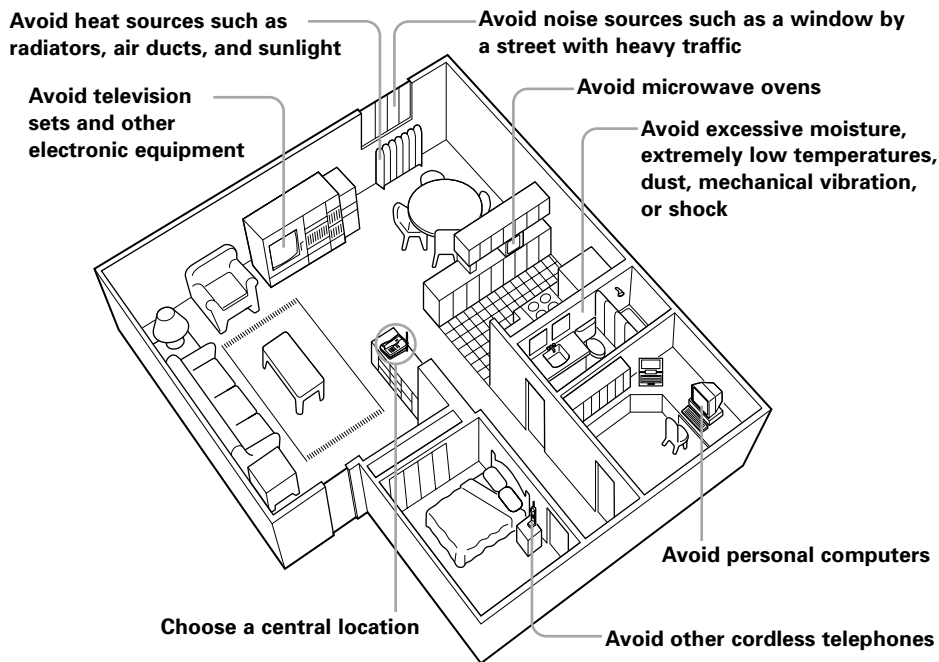

- You should charge your handset for 15-20 hours before using the phone.
- The location should be close to both a phone jack and a continuous power outlet which is not switchable.
- Keep the base and handset away from sources of electrical noise such as motors, microwave ovens, and fluorescent lighting.
- The base can be placed on a desk, table top, or mounted on the wall.

Step 2 (continued)

Connect the base unit

If you want to install the base unit on the wall, see page 33.

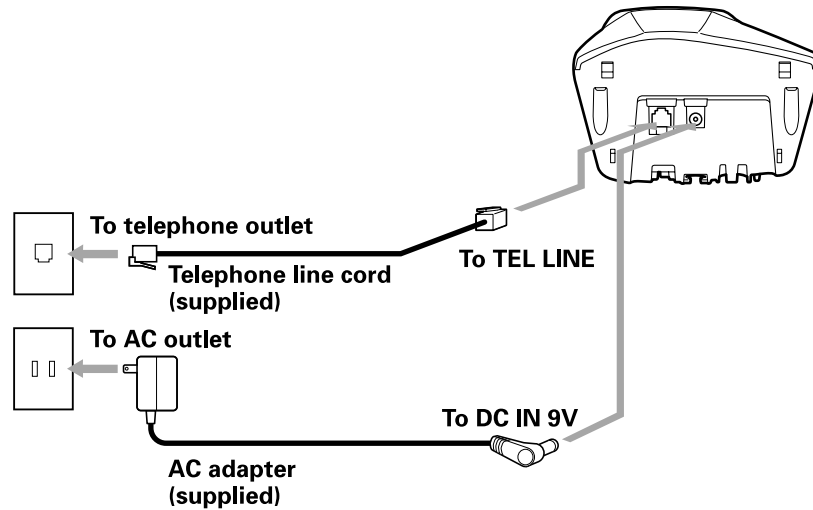

- 1** Connect the telephone line cord to the **TEL LINE** jack and to a telephone outlet.
- 2** Connect the AC adapter to the **DC IN 9V** jack and to a standard 120V AC wall outlet.
- 3** Set the base unit on a desk or tabletop and place the handset in the base unit.

Notes

- Place the power cord where it will not create a trip hazard, or where it could become chafed and create a fire or electrical hazard.
- Place the handset in the base unit with the keys and display facing upward.

Surge Protectors

It is recommended to use a surge protector for AC and telephone connection. Lightning and power surges ARE NOT covered under warranty for this product.

Step 2 (continued)

Notes

- Use only the supplied AD-310 AC adapter. Do not use any other AC adapter.
- Place the base unit close to the AC outlet so that you can unplug the AC adapter easily.
- Connect the AC adapter to a continuous power supply.

Polarity of the plug

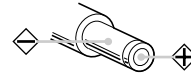

Tip

If your telephone outlet isn't modular, contact your telephone company for assistance.

Modular



Choose the dialing mode

Most phone systems use tone dialing which sends DTMF tones through the phone lines. However some phone systems still use pulse dialing such as in rural areas. The default setting is tone dialing. Depending on your dialing system, set the mode as follows:

- 1 Press and hold **CID/MENU**. The following screen appears.

```
1# Auto Talk: Off
2 CIDCW      : On
3 Area Code:
```

- 2 Use **▼** or **4** to move the pointer to the selection that you would like to change.

```
2 CIDCW      : On
3 Area Code:
4# Dial      : Tone
```

- 3 Press the **SELECT** key to toggle between "Tone" or "Pulse".

- 4 After you have made your selections, press **OFF** or return the handset to the base.

If you are not sure of your dialing system, set for tone dialing. Make a trial call. If the call connects, leave the setting as is, otherwise set for pulse dialing.

Note

Make sure your battery pack is fully charged before choosing the dial mode.

Step 3

Preparing the battery pack

Charge the battery pack for 15-20 hours before connecting the phone line.

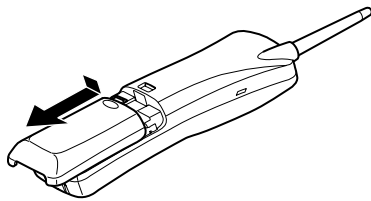

- 1** Press and slide the battery compartment cover toward the bottom of the unit.

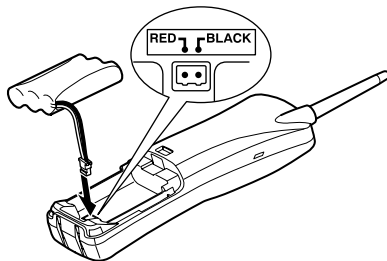

- 2** Connect the battery pack connector with the correct polarity (black and red wires), then insert the battery pack into the battery compartment.

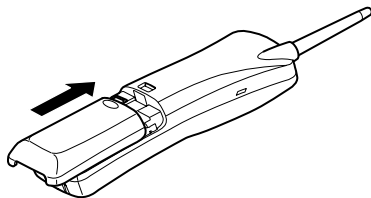

- 3** Securely close the battery compartment cover by sliding it up until it snaps into place.

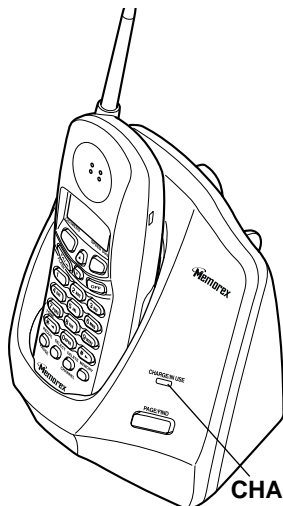

- 4** Place the handset in the base unit with the keys and display facing upward. This position lets you see Caller ID messages on the display.

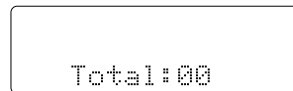

When the handset has been properly placed on the charging terminals of the base unit, the "**CHARGE/IN USE**" LED of the base unit lights and charging begins. Charge the battery for 15-20 hours.

CHARGE/IN USE LED

Step 3 (continued)

Battery use time (per charge)

From fully charged

- 7 hours continuous use.
- 14 days when the handset is in the standby mode.

When the battery charge becomes low

When the voltage of battery pack is very low and needs to be charged, the phone eliminates functions to save power. If the phone is not in use, "Low Battery" flashes and none of the keys will operate. If the phone is in use, "Low Battery" flashes and the handset beeps. Complete your conversation as quickly as possible and return the handset to the base unit for charging.



Low Battery

Note

Even when the battery pack is not being used, it will gradually discharge over a long period.

Cleaning the battery contacts

To maintain a good charge, it is important to clean all battery contacts on the handset and base unit with a pencil eraser or other contact cleaner, if necessary, about once a month.

Do not use any liquids or solvents.

Making Calls

Dialing from standby

- 1** Dial the phone number. (up to 32 digits.)
Example: Enter 800-919-3647
- 2** Press **TALK/FLASH**. "Talk" flashes on the display. Then the volume setting appears for a few seconds.
Example: Volume level "High"
- 3** The number is dialed. After about 5 seconds, the call-time display appears.
- 4** To hang up, press **OFF** or place the handset in the base. The call-time will be displayed for about 5 seconds.

8009193647 ■

Talk
Volume High

Talk 0:00
8009193647

5:15

Other Operations

To	Do this
To improve reception.	Press DELETE/CHANNEL .
To temporarily switch to tone dial (When the base is set to pulse mode).	Press */◀/TONE . The following numbers dialed will be sent as tone dialing.
To enter a pause in the dialing sequence.	Press REDIAL/PAUSE .

Dialing from talk mode

- 1** Pick up the handset.
- 2** Press **TALK/FLASH**. "Talk" and the volume setting appear on the display.
- 3** Dial the phone number.
 After about 5 seconds, the call-time display appears.
Example: Enter 800-919-3647
- 4** To hang up, press **OFF** or place the handset in the base. The call-time will be displayed for about 5 seconds. The phone returns to standby.

Talk
Volume High

Talk 0:17
8009193647

10:03

Redialing

The **REDIAL/PAUSE** key redials the last number dialed. The redialed number can be up to 32 digits long.

Receiving Calls

Receiving a call

- 1** Phone rings.

When the handset receives a Caller ID message, the following display appears.

Incoming Call

12/21 12:30PM
Menorex
800-919-3647

- 2** Press **TALK/FLASH**. "Talk" and the volume setting appears on the display.

Talk 0:00
Volume High

- 3** To hang up, press **OFF** or place the handset in the base.
The call time will be displayed for about 5 seconds.

115:35

Instant Talk when ringing

When the Instant Talk setting is on and there is an incoming call, simply lift the handset from the base unit to answer the phone.

Any key when ringing

When the Instant Talk setting is on and the handset is off the base, press **TALK/FLASH**, any number key, ***/*/TONE** or **#/#** to answer the incoming call.

Call Waiting

Note: You must subscribe to Call Waiting service to use this feature.

When a call is received during a telephone call already in progress, press **TALK/FLASH** to switch to the new call. If you also subscribe to Caller ID on Call Waiting, you will see the name and number of the caller in Call Waiting (See page 31.)

Note

Instant Talk is initially set to off as the default setting.
To turn it on, proceed to setting Caller ID options. (See page 26)

Handset Ringer and Earpiece Volume

Handset ringer tone

In the standby mode, press ▲ or ▼. Each time ▲ or ▼ is pressed, the ringer tone setting changes and the selected ringer tone sounds for 2 seconds.

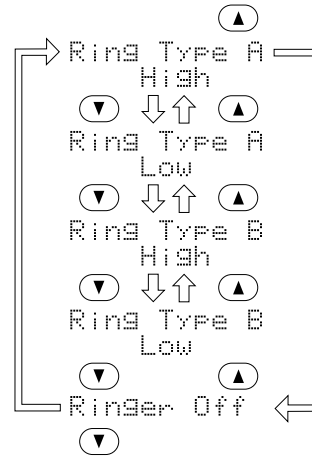

Handset earpiece volume

During a telephone call, pressing ▲ or ▼ will change the earpiece volume of the handset. This setting will remain in effect after the telephone call has ended.



When you press ▲ in Maximum mode or press ▼ in Low mode, an error tone sounds.

Ringer Mute

You can temporarily mute the ringer tone. When the handset is off the base and the phone is ringing, press **OFF**. The ringer tone will return to normal starting with the next incoming call.

Using the Page Feature

To locate the handset (while it's off the base)

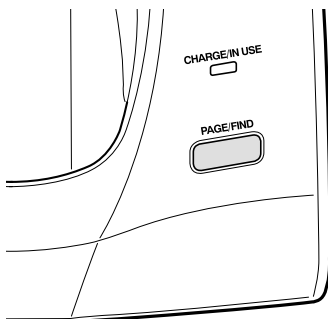

- 1** Press **PAGE/FIND** on the base.
- 2** The handset beeps for 60 seconds.
- 3** Press any key on the handset or **PAGE/FIND** on the base, or return the handset to the base to cancel the page.

Memory Storing

You can store up to 10 phone numbers in the dial memory.

Storing phone numbers and names

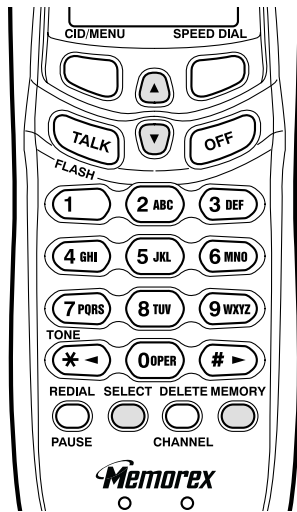

- 1 Press and hold **MEMORY** until a tone sounds and "Memory Store" is displayed.

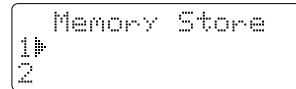

- 2 Press **▲** or **▼** to scroll to the memory location where you would like to store the number.

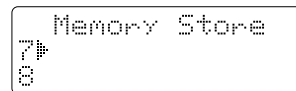

Or press the keypad (0 to 9) to select the memory location where you would like to store the number.

- 3 Press **SELECT**.
When an empty memory location is selected, "Store Name" is displayed. The cursor flashes indicating that the display is ready for the name to be entered.

If this screen appears, the memory location is reserved. You must edit the location. (See page 23.)

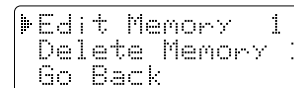
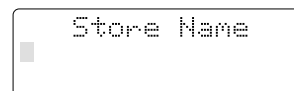

Notes

- Whenever you are using a menu screen, you must press a key within 30 seconds or the phone will return to standby. If you return the handset in the cradle, the phone will return to standby too.
- You have 30 seconds after pressing **MEMORY** to enter the number you wish to store. Otherwise, an error tone will sound.

Memory Storing (continued)

- 4** Use the number keys to enter the name.
The name cannot exceed 14 characters.
- See the "Steps for entering names and special characters", page 20.
 - Use the ***/◀/TONE** and **#/▶** to move the cursor to the desired position.
 - Use the **DELETE/CHANNEL** key to delete characters as needed.
 - Press and hold **DELETE/CHANNEL** to delete all the characters.
 - If a name is not required, go to step 5.

- 5** Press **SELECT**.
"Store Number" is displayed. The cursor flashes indicating that the display is ready for the number to be entered.

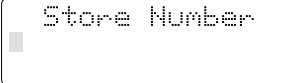

- 6** Use the keypad, ***/◀/TONE**, **#/▶**, or **REDIAL/PAUSE** keys to enter the phone number. The phone number can be up to 20 digits.
- Use the **REDIAL/PAUSE** key to enter pause in the dialing sequence. The display shows a "P".



Note The pause feature is useful for long distance calling, credit card dialing, or sequences that require a pause between digits.

- Use the **DELETE/CHANNEL** key to delete digits as needed.

- 7** Press **SELECT**.
The handset beeps and displays the confirmation screen. The memory storage is complete.

For example if you store a name and number into memory location number 7, the display shows "Memory 7 Stored".

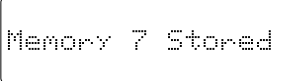

After about 2 seconds, "Memory Store" is displayed.

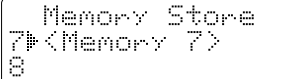

Memory Storing (continued)

Steps for entering names and special characters

Refer to the letters on the number keys to select the desired characters. With each press of a numeric key, the displayed character appears in the following order: Upper case letters first, lower case letters next and finally the number corresponding to the key.

keys	Number of times key is pressed								
	1	2	3	4	5	6	7	8	9
1	1								
2 ABC	A	B	C	a	b	c	2		
3 DEF	D	E	F	d	e	f	3		
4 GHI	G	H	I	g	h	i	4		
5 JKL	J	K	L	j	k	l	5		
6 MNO	M	N	O	m	n	o	6		
7 PQRS	P	Q	R	S	P	q	r	s	7
8 TUV	T	U	V	t	u	v	8		
9 WXYZ	W	X	Y	Z	w	x	y	z	9
0 OPER	*	#	-	&	()	(blank)	0	

If you make a mistake while entering a name

Use ***/◀/TONE** or **#/▶** to move the cursor to the incorrect character. Press **DELETE/CHANNEL** to erase the wrong character, then enter the correct character. To delete all characters, press and hold **DELETE/CHANNEL**.

For example, to enter **Memorex**:

- 1) Pick up the handset and press and hold **MEMORY**.
- 2) Enter a number or press **▲**, **▼** to select a memory location number.
- 3) Press **SELECT**.
- 4) Press **6** once.
- 5) Press **3** five times.
- 6) Press **6** four times, then press **#/▶** to move the cursor to the right.

Note If the next character uses the same number key, you must press **#/▶** to move the cursor over. Otherwise the next time you press the number key, it changes the character that was previously set.

- 7) Press **6** six times.
- 8) Press **7** seven times.
- 9) Press **3** five times.
- 10) Press **9** six times.
- 11) When finished, press **SELECT**.

To continue to store the telephone number, proceed to step 6 on page 19.

Note

The pause feature is useful for long distance calling, credit card dialing, or sequences that require a pause between digits.

Memory Dialing

Making calls with memory dialing

Dialing from standby

- 1** Press **MEMORY**.
The handset displays your programmed memory locations.
- 2** Press the **▲** and **▼** keys to select the memory location you would like to dial.
For example if the **▼** key is pressed once, the pointer moves down to the next memory location number.

Or press the number keypad to select the memory location you would like to dial.
For example if you press 5 on the keypad, the display shows memory location number 5 with the pointer in that line.
- 3** Press **TALK/FLASH**, "Talk" momentarily flashes on the display and the volume setting appears. Then the displayed number is dialed.

```

1▶ Memorex
2 JOHN DOE
3 MOM AND DAD
    
```

```

2 JOHN DOE
3 MOM AND DAD
4▶
    
```

```

5▶ JOHN SMITH
6 <Memory06>
7
    
```

```

>Talk<
0123456789012
    
```

Notes

- To cancel memory selection, press **OFF** during selecting the memory location. The handset returns to standby.
- Whenever you are using a menu screen, you must press a key within 30 seconds or the phone will return to standby.
- If you press **SELECT** before **TALK/FLASH**, you can confirm the name and the number stored in the selected memory location.

Memory Dialing (continued)

Display a Programmed Number

Press **MEMORY**, then use the ***/◀/TONE** or **#/▶** keys to toggle between the name and the number displays.

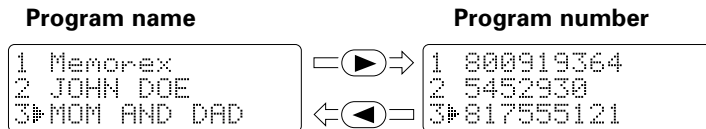

Note

When the stored phone number has 15 or more digits, "▶" is displayed next to the 13th digit. Press **#/▶** to see the extra digits and ***/◀/TONE** to return.

```

5 012345678901
6▶0118150539264+
7
```

Dialing from talk mode

- 1 Press **TALK/FLASH**.
"Talk" and the volume setting appear on the display.
- 2 Press **MEMORY**.
- 3 Press the number keypad to select the memory location of the desired phone number. The selected phone number is displayed. Then the number is dialed.

```

Talk
Volume High
```

```

Talk 0:00
```

```

Talk 0:35
0123456789012
```

Note

If you select a memory location that does not have a stored number, the handset will beep rapidly and the phone will not dial.

Memory Editing

Editing a stored name and/or phone number

- 1** Press and hold **MEMORY** until a tone sounds and "Memory Store" is displayed.
- 2** Press the **▲** or **▼** keys or number keypad to select the memory location you would like to edit.
- 3** Press **SELECT**.
The following screen appears with the memory location number that you have selected in the display.
For example, if you selected memory location number 1, the display shows memory 1 selected.
- 4** Press the **▲** or **▼** key to select "Edit Memory", then press **SELECT**.
The following screen appears. The cursor flashes indicating that the display is ready for the name to be edited.
When a name has not been stored, the cursor appears at the beginning of the second line.
- 5** Press the number keys, **#/▶**, ***/◀/TONE**, or **DELETE/CHANNEL** to edit the name. (See page 19.)
To edit only the phone number, skip this step.
- 6** Press **SELECT**.
The following screen appears. The cursor flashes indicating that the display is ready for the number to be edited.
- 7** Use the number keypad, **#/▶**, ***/◀/TONE**, **REDIAL/PAUSE** or **DELETE/CHANNEL** key to edit the phone number. The phone number cannot exceed 20 digits. (See page 19.)
When the phone number is not to be edited, skip this step.
- 8** Press **SELECT**.
The handset beeps and displays the confirmation screen. The memory storage is complete.
For example if you store a name and number into memory location number 1, the display shows "Memory 1 Stored".
After about 2 seconds, "Memory Store" is displayed.
- 9** Press **OFF** to return to standby.

```
Memory Store
1▶Memorex
2▶JOHN DOE
```

```
Memory Store
1 Memorex
2▶JOHN DOE
```

```
▶Edit Memory 1
Delete Memory 1
Go Back
```

```
Store Name
Memorex█
```

```
Store Number
800919364█
```

```
Memory 1 Stored
```

```
Memory Store
1▶Memorex
2▶JOHN DOE
```

Memory Erasing

Erasing a stored name and phone number

1 Press and hold **MEMORY** until a tone sounds and "Memory Store" is displayed.

```
Memory Store
1 Memorex
2 JOHN DOE
```

2 Press the ▲ or ▼ keys or number keypad to select the memory location you would like to erase.

3 Press **SELECT**.

Example: Memory 2 is selected

```
► Edit Memory 2
Delete Memory 2
Go Back
```

4 Press ▼ to move the pointer down to "Delete Memory".

```
Edit Memory 2
► Delete Memory 2
Go Back
```

5 Press **SELECT**. The following confirmation screen appears.

```
Delete Memory 2?
Yes
► No
```

6 Press ▲ to move the pointer to "Yes".

7 Press **SELECT** or **DELETE/CHANNEL**. A tone sounds and the memory is deleted. The following screen appears.

```
Memory 2 Deleted
```

8 After 2 seconds the display returns to the "Memory Store" screen. You may select another number to delete (return to step 2).

```
Memory Store
1 Memorex
2 ►
```

9 Press **OFF** to return to standby.



Speed Dial Feature

You can store your most frequently dialed number in the speed dialing location. The speed dialing allows you to dial a number with one key press. (There is no need to press **TALK/FLASH**. The phone will automatically dial the number stored.)

Storing and Editing the Speed Dial

- 1 Press and hold **SPEED DIAL**. The following screen appears.

```
Store Number
█
```

If this screen appears, there is a number already stored. Press **▲** or **▼** to select "Edit Number", then press **SELECT**.

```
▶Edit Number
Delete Number
Go Back
```

- 2 Store the number by following step 6 under "Storing phone number and names" on page 19.

```
Store Number
800█
```

- 3 Press **SELECT**. The handset beeps and displays the confirmation screen. The memory storage is complete.

```
Number Stored
```

Note

Memory location for the Speed Dial is independent from the memory location for Memory dial.

Making calls with speed dialing

In the standby mode, simply press **SPEED DIAL**. The number stored in the Speed Dial memory location is instantly dialed.

Note

If the Speed Dial does not have a stored number, the handset will beep rapidly and the phone will not dial.

Deleting the Speed Dial

- 1 Press and hold **SPEED DIAL**. The following screen appears.

```
▶Edit Number
Delete Number
Go Back
```

- 2 Press **▲** or **▼** to select "Delete Number".

- 3 Press **SELECT**. The following confirmation screen appears.

```
Delete Number ?
Yes
▶No
```

- 4 Press **▲** to move the pointer to "Yes".

- 5 Press **SELECT** or **DELETE/CHANNEL**. The handset beeps and displays the confirmation screen. After about 2 seconds, the phone returns to standby.

```
Number Deleted
```

Caller ID Features

Caller ID

When the telephone rings, the Caller ID feature allows you to view the caller's name and phone number on the display before you answer the phone.

The handset displays the phone number of the incoming call, the name, time, and the number of calls. Additionally, you can dial the displayed number and store the information for memory dialing.

Setting Caller ID options/Language

There are three Caller ID setup options available; they are Instant Talk, CIDCW (Caller ID on Call Waiting), and Area Code.

Instant Talk allows you to answer the phone without pressing the **TALK/FLASH** button. If the phone rings when Instant Talk is on, simply remove the handset from the base and the phone automatically answers the call. If the phone rings when Instant Talk is off, you must press **TALK/FLASH** to answer the call.

Note Instant Talk is referred to as Auto Talk in the screen.

Caller ID on Call Waiting (CIDCW) performs the same as regular Caller ID on a Call Waiting number. **You must subscribe to CIDCW from your phone company in order to use this feature.**

If you enter a 3-digit area code number in the Area Code option, your local area code does not appear in Caller ID messages. When reviewing Caller ID messages, you will see only the local seven digit number. For calls received from outside your local area code, you will see a full 10-digit number.

Note If your calling area requires 10-digit dialing, do not program this option.

Language option can be used to choose the language of your display. You can select either English or French.

To change your Caller ID options/Language:

1 Press and hold **CID/MENU**. The following screen appears.

```
1#Auto Talk:Off
2 CIDCW      :On
3 Area Code:
```

2 Use **▲** and **▼** or a number key (**1-5**) to move the pointer to the selection that you would like to change.

- For Instant Talk, press the **SELECT** key to toggle between On or Off.
- For CIDCW, press the **SELECT** key to toggle between On or Off.
- To change the Area Code, press **SELECT** and use the number keypad to enter the Area Code, then press **SELECT** again. (You will hear a confirmation tone indicating the area code has been changed.)
- To set up the language of your display, move the pointer to "Language". Press **SELECT** to select "Eng" (English) or "Fr." (French).

```
3 Area Code:
4 Dial      : Tone
5#Language :Eng
```

3 After you have made your selections, press **OFF** and return the handset to the base.

Caller ID Features (continued)

When the telephone rings

- 1** When phone rings, the **CHARGE/IN USE** LED blinks. On the second ring, the display shows the caller's phone number, along with the date and time. The incoming call information is stored. If the Caller ID service includes the caller's name, it appears on the display (up to 15 letters).

The date and time received	5/11 12:30PM
Caller's name	Memorex
Caller's phone number	800-919-3647

Here are some typical displays:

When the phone number and name data are received

```
5/11 12:30PM
Memorex
800-919-3647
```

When a private number is received

```
5/11 12:30PM
Memorex
Private Number
```

When a private name is received

```
5/11 12:30PM
Private Name
800-919-3647
```

When an unknown number is received

```
5/11 12:30PM
Memorex
Unknown Number
```

When an unknown name is received

```
5/11 12:30PM
Unknown Name
800-919-3647
```

When invalid data is received

```
Incomplete Data
```

- 2** When the telephone is answered, the display changes to "Talk".

Notes

- If you answer a call before the Caller ID message is received (Example: before the second ring), the Caller ID message will not appear.
- When the call is received via a telephone company that does not offer Caller ID service, the caller's phone number and name do not appear. (This includes international calls.)
- When the call is via a private branch exchange (PBX), the caller's phone number and name may not appear.
- Data errors appear as "■".

Caller ID Features (continued)

Viewing the Caller ID message list

The Caller ID list stores information for up to 30 incoming calls - even unanswered calls.

- 1 Press **CID/MENU**. The summary screen appears. When there are new messages you have received, "New" and the number of calls are displayed. The summary screen shows how many new calls are stored, along with the total of new and old calls stored in the list.

```
New :01
Total:02
```

- 2 Press **▼** to display the latest Caller ID message.

```
5/17 12:30PM 03
Menorex
800-919-3647
```

- 3 Press **▼** to see the next message. Or press **▲** to see the previous message.

- 4 Press **OFF** to return to standby.

Long Distance Calls and Area Code Setting/Cancellation

Pressing **1** while the incoming call information is displayed (in step 1) will set or cancel a long distance call. The prefix "1-" will be displayed at the beginning of the phone number when a long distance call is set. Pressing **1** again will cancel the long distance call setting. Pressing **3** will set or cancel an area code setting.

```
5/17 12:30PM
Menorex
1-800-919-3647
```

Notes

- If a call comes in via a telephone system that does not offer Caller ID service, no information is stored.
- Each message can be up to 15 characters for the phone number and the name.
- If the phone number is more than 15 characters, only "1" will be displayed at the beginning of the phone number when a long distance call is set.
- In Caller ID operation, if no key is pressed for more than 30 seconds, an error tone sounds and the telephone returns to the standby mode.
- The number of calls from the same Caller ID appears next to the received time. Once you read the new message, the number will disappear.

Caller ID Features (continued)

Deleting information from the Caller ID list

Your phone stores up to 30 Caller ID messages. If more new calls are received, messages stored in the list are deleted beginning with the oldest message in the list. Data can also be deleted manually.

Deleting a Caller ID message

- 1 Press *CID/MENU*.
- 2 Press ▲ or ▼ to select the message that you would like to delete. (See page 28.)
- 3 Press *DELETE/CHANNEL*.
- 4 Press ▲ or ▼ to select "Yes" or "No".
- 5 Press *SELECT* or *DELETE/CHANNEL*.

```
5/17 12:30PM
Memorex
800-919-3647
```

```
Delete Message?
▶Yes
No
```

When the pointer is at "Yes":

A tone sounds and the next Caller ID message is displayed.

When the pointer is at "No":

The display returns to the Caller ID display.

Deleting all Caller ID names/numbers

- 1 Press *CID/MENU*.
- 2 Press *DELETE/CHANNEL*, while the summary screen is displayed.
- 3 Press ▲ or ▼ to select "Yes" or "No".
- 4 Press *SELECT* or *DELETE/CHANNEL*.

```
New :01
Total:02
```

```
Delete All ?
Yes
▶No
```

When the pointer is at "Yes":

A tone sounds and all stored Caller ID messages are deleted.

```
Total:00
```

When the pointer is at "No":

The display returns to the summary screen.

```
New :01
Total:02
```

Notes

- While using the "Delete Message ?" or "Delete All ?" screen, if no key is pressed for more than 30 seconds, an error tone sounds and the telephone returns to standby.
- If you get an incoming call or page, the deleting operation is canceled and the telephone returns to standby so you can answer the call or page.

Caller ID Features (continued)

Using the Caller ID list

Calling a party from the Caller ID list

You can place a call from the Caller ID list. Your telephone stores up to 30 messages.

- 1** Press **CID/MENU**.
- 2** Press **▲** or **▼** to select the phone number that you want to dial.
- 3** Press **TALK/FLASH**.
The displayed phone number dials automatically.

```
5/17 12:30PM
Memorex
800-919-3647
```

```
TALK
8009193647
```

Note

You cannot make a call from the Caller ID list if your phone is connected to private branch exchange (PBX).

Storing Caller ID messages in Memory

Messages shown in the Caller ID list can be stored for memory dialing. Using the incoming call information (i.e., Caller ID list), the phone number of the party on the Caller ID list can be stored in memory dialing.

- 1** Press **CID/MENU**.
- 2** Display the phone number to be stored from the Caller ID list. (See page 28.)
- 3** Press **MEMORY**.
- 4** Press the **▲** or **▼** keys or number keypad to select the memory location where you wish to store the name and number from the Caller ID list.

```
5/17 12:30PM
Memorex
800-919-3647
```

```
Select Location
1 Memorex
2 JONE DOE
```

- 5** Press **SELECT**.
A tone sounds. The number is stored in memory, and the display returns to the Caller ID list.

```
5/17 12:30PM
Memorex
800-919-3647
```

Notes

- If a message has already been stored in the selected memory location, a verification screen is displayed. Press **▲** to select "Yes". Press **SELECT** to overwrite. The display returns to the Caller ID list.

```
Replace Memory ?
Yes
No
```

- You cannot store a Caller ID message if no phone number appears in the message.

Caller ID Features (continued)

Using "Caller ID with Call Waiting" service

"Caller ID" and "Call Waiting" are separate services. CIDCW (Caller ID on Call Waiting) performs the same as regular Caller ID on a Call Waiting number. You must subscribe to the "Caller ID with Call Waiting (CIDCW)" service from your telephone company before you can use the following features.

The "Call Waiting" service can also be used independently. Please contact your telephone company for details.

When a new incoming call arrives during your current telephone call, the phone number appears. (The name of the new caller is displayed, depending upon the telephone service.)

- 1 When a new incoming call arrives during your current telephone call, the phone number and the name of the caller is displayed.



```
Talk 10:30
Memorex
800-919-3647
```

- 2 Press **TALK/FLASH**.
You will be able to talk with the person that has just called. The person with whom you were talking will be put on hold.

- 3 To return to the first caller, press **TALK/FLASH** again.

Additional Information

Changing the digital security code

The digital security code is an identification code used to connect the handset and the base unit. Normally, setting the code is not necessary.

The first time you charge your handset, the security code is automatically set. (See page 8.) In the rare situation that you suspect another cordless telephone is using the same security code, you can change the code as follows.

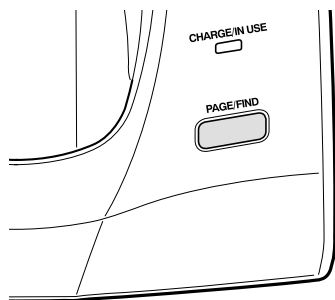

- 1** Remove the handset from the base unit. Press and hold **PAGE/FIND**.
- 2** While the handset is emitting the paging sound, place the handset on the base unit holding **PAGE/FIND**. The paging tone stops. Leave the handset on the base for more than 3 seconds. A random, new security code is set.

Note

If the handset battery pack is completely discharged or the battery pack is removed, the digital security code will be lost. If this happens, a new security code is set automatically next time the battery pack is charged.

Additional Information (continued)

Mounting the base unit on a wall

Standard wall plate mounting

This phone can be mounted on any standard telephone wall plate.

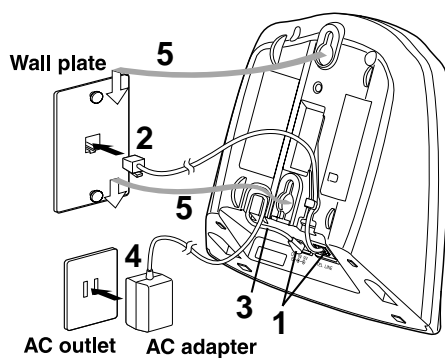

- 1** Plug the telephone line cord to the **TEL LINE** jack and the AC adapter to the **DC IN 9V** jack.
 - 2** Plug the telephone line cord into the telephone outlet.
 - 3** Place the AC adapter cord inside the molded wiring channel.
 - 4** Plug the AC adapter into a standard 120V AC wall outlet.
- Note** Use only the AC adapter supplied with this phone.

- 5** Align the mounting slots on the base with the mounting posts on the wall. Push in and down until the phone is firmly seated.

[Direct wall plate mounting]

If you don't have a standard wall plate, you can mount your phone directly to the wall. Before doing this, consider the following:

- Avoid electrical cables, pipes, or other items behind the mounting location. That could cause a hazard when inserting screws into the wall.
- Try to mount your phone within 5 feet of a working phone jack to avoid excessive cord lengths.
- Make sure the wall material is capable of supporting the weight of the base and handset.
- Use #10 screws (minimum length of 1-3/8 inches) with anchoring devices suitable for the wall material where the base unit will be placed.

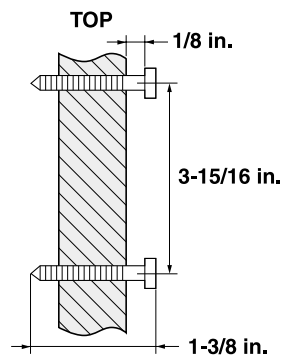

- 1** Insert two mounting screws into the wall, (with their appropriate anchoring device), 3-15/16 inches apart. Allow about 1/8 of an inch between the wall and screw heads for mounting the phone.
- 2** Refer to steps 1 through 5 above to mount the telephone.

Additional Information (continued)

Note on power sources

Battery replacement and handling

When the operating time becomes short, even after a battery is recharged, please replace the battery. With normal usage, your battery should last about one year. Please contact your place of purchase for a replacement battery.

Warning: To avoid the risk of personal injury or property damage from fire or electrical shock, only use the Memorex battery model and Memorex adapter model specifically designated for this product.

Power Failure

During the period that the power is off, you will not be able to make or receive calls with the telephone.

RECYCLING NICKEL-CADMIUM BATTERIES

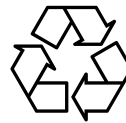

NICKEL-CADMIUM BATTERIES MUST BE DISPOSED OF PROPERLY.

Ni-Cd

Nickel-cadmium cells are used in the battery pack. Please take your used nickel-cadmium battery packs to a store that recycles nickel-cadmium batteries.

Caution

- Use the specified battery pack.
- Do not remove the battery from the handset to charge it.
- Never throw the battery into a fire, disassemble it, or heat it.
- Do not remove or damage the battery casing.

Maintenance

When slightly dirty

Wipe with a soft, dry cloth.

When very dirty

Wipe with a soft cloth that has been dampened with a mild dishwashing detergent. Dry with a dry cloth.

When the charging terminals become dirty

Wipe with a dry cloth or pencil eraser, if necessary.

Caution

Do not use paint thinner, benzene, alcohol, or other chemical products. Doing so may discolor the surface of the telephone and damage the finish.

Additional Information (continued)

Troubleshooting

If your phone is not performing to your expectations, please try these simple steps first.

Symptom	Suggestion
The CHARGE/IN USE LED light won't come on when the handset is placed in the base unit.	<ul style="list-style-type: none"> • Make sure the AC adapter is plugged into the base unit and wall outlet. • Make sure the handset is properly seated in the base unit. • Make sure the charging contacts on the handset and base unit are clean.
The audio sounds weak and/or scratchy.	<ul style="list-style-type: none"> • Move the handset and or base unit to a different location away from metal objects or appliances and try again. • Press DELETE/CHANNEL to help eliminate background noise. • Make sure that you are not too far from the base.
Can't make or receive calls.	<ul style="list-style-type: none"> • Check both ends of the base telephone line cord. • Make sure the AC adapter is plugged into the base unit and wall outlet. • Disconnect the AC adapter for a few minutes, then reconnect it. • Reset the digital security code (See page 32). • Make sure that you are not too far from the base unit.
The handset doesn't receive a page.	<ul style="list-style-type: none"> • The battery pack may be weak. Charge the battery on the base unit for 15-20 hours. • The handset may be too far away from the base unit. • Place the base unit away from appliances or metal objects. • Reset the digital security code (See page 32).
The Caller ID does not display.	<ul style="list-style-type: none"> • The handset was picked up before the second ring. • The call was placed through a switch board. • Call your local telephone company to verify your Caller ID service is current.
Severe noise interference.	<ul style="list-style-type: none"> • Keep the handset away from microwave ovens, computers, remote control toys, wireless microphones, alarm systems, intercoms, room monitors, fluorescent lights and electrical appliances. • Move to another location or turn off the source of interference.

For additional set-up or operating assistance, please visit our WEBSITE at www.memcorpinc.com or contact CUSTOMER SERVICE at 1-800-919-3647.

FOR PARTS AND ACCESSORIES, CONTACT FOX INT'L AT 1-800-321-6993.

Additional Information (continued)

I.C. Notice

Industrial Canada Information

Terminal Equipment

Notice: This equipment meets the applicable Industry Canada Terminal Equipment Technical Specifications. This is confirmed by the registration number. The abbreviation, IC, before the registration number signifies that registration was performed based on a Declaration of Conformity indicating that Industry Canada technical specifications were met. It does not imply that Industry Canada approved the equipment.

Notice: The Ringer Equivalence Number (REN) for this terminal equipment is marked on the equipment itself. The REN assigned to each terminal equipment provides an indication of the maximum number of terminals allowed to be connected to a telephone interface. The termination on an interface may consist of any combination of devices subject only to the requirement that the sum of the Ringer Equivalence Numbers of all the devices does not exceed five.

Radio Equipment

The term "IC:" before the radio certification number only signifies that Industrial Canada technical specifications were met.

Operation is subject to the following two conditions: (1) this device may not cause interference, and (2) this device must accept any interference, including interference that may cause undesired operation of the device. "Privacy of communications may not be ensured when using this telephone".

Index

B

- Battery pack
 - Preparing and charging13
 - Replacement and handling34

C

- Caller ID service
 - Calling from the Caller ID list30
 - Deleting the Caller ID list29
 - Storing the data of the
 - Caller ID list to Memory30
 - Viewing Caller ID message list28
- Caller ID with Call Waiting31
- Connection11

D

- Deleting the Speed Dial25
- Dialing mode12
- Digital security code8, 32

E, H, I

- Editing a stored name and/or phone number23
- Erasing a stored name and phone number24
- Handset earpiece volume17
- I.C. Notice36

L, M, O

- Language26
- Making calls
 - Dialing from standby15
 - Dialing from talk mode15
 - Redialing15
- Making calls with memory dialing21
- Making calls with speed dialing25
- Mounting the base unit on a wall33

P, R

- Package contents9
- Receiving a call16
- Ringer tone17

S

- Setting Caller ID options26
- Setup
 - Base unit10
 - Handset13
- Storing and Editing the Speed Dial25
- Storing phone numbers and names18

T, U

- Troubleshooting35
- Using "Caller ID with Call Waiting" service31

LIMITED WARRANTY—CORDLESS TELEPHONES

We at MEMOREX believe you will be pleased with your new Cordless Telephone. Please read this Warranty carefully. Memorex warrants this product to be free from manufacturing defects including original parts and workmanship for a period of one (1) year from the date of original purchase in, and if used in, the United States.

Before attempting to have your unit repaired or replaced please check the troubleshooting section of your manual and any additional FAQs available at www.memcorpinc.com. However, if you should find your unit is not operating properly during the first ninety (90) days of ownership, you should first contact your original place of purchase to confirm if you are still covered under their return policy. If necessary, Memorex will provide one of the following options (at Memorex's discretion), providing the manufacturing defect is verified along with the date of purchase.

- Repair service for one (1) year from date of original purchase at no charge for labor and parts (excluding batteries) at Memorex's authorized warranty service facility, providing the manufacturing defect is verified along with the date of purchase.
- Replacement of defective unit with either a new, refurbished, or equivalent model at no charge for one (1) year from date of original purchase.

This warranty is void if the product is:

- A) Damaged through negligence, abuse, misuse, accident, or acts of God.
- B) Used in commercial applications or rentals.
- C) Modified or repaired by anyone other than Memorex or their expressly authorized representative.
- D) Damage resulting from the improper connection to equipment of other manufacturers.

This warranty does not cover:

- A) Cost incurred in the shipping of the product to and from the Memorex authorized repair facility listed.
- B) Damage or improper operation caused by the failure to follow the operating instructions provided with the product.
- C) Routine adjustments to the product, which can be performed by the customer as outlined in the owner's manual.
- D) Signal reception problems caused by external factors.
- E) Products not purchased in the United States.
- F) Damage to the products used outside the United States.
- G) Replacement of rechargeable batteries.

In the event that service is required under this warranty, please visit our website, www.memcorpinc.com for detailed instructions or call 1-800-919-3647.

THIS WARRANTY IS NON-TRANSFERABLE AND APPLIES SOLELY TO THE ORIGINAL PURCHASER AND DOES NOT EXTEND TO SUBSEQUENT OWNERS OF THE PRODUCT. ANY APPLICABLE IMPLIED WARRANTIES, INCLUDING THE WARRANTY OF MERCHANTABILITY, ARE LIMITED IN DURATION TO A PERIOD OF THE EXPRESSED WARRANTY AS PROVIDED HEREIN BEGINNING WITH THE DATE OF THE ORIGINAL PURCHASE AT RETAIL AND NO WARRANTIES, WHETHER EXPRESSED OR IMPLIED SHALL APPLY TO THE PRODUCT THEREAFTER. MEMOREX MAKES NO WARRANTY AS TO THE FITNESS OF THE PRODUCT FOR ANY PARTICULAR PURPOSE OR USE.

THE EXTENT OF MEMOREX'S LIABILITY UNDER THIS LIMITED WARRANTY IS THE REPAIR OR REPLACEMENT PROVIDED ABOVE AT THE SOLE DISCRETION OF MEMOREX. IN NO EVENT SHALL MEMOREX'S LIABILITY EXCEED THE PURCHASE PRICE PAID BY THE PURCHASER. UNDER NO CIRCUMSTANCES SHALL MEMOREX BE LIABLE FOR ANY LOSS, DIRECT, INDIRECT, INCIDENTAL, FORESEEN, UNFORESEEN, SPECIAL, OR CONSEQUENTIAL DAMAGE ARISING OUT OF OR IN CONNECTION WITH THE USE OF THIS PRODUCT.

THIS WARRANTY IS VALID ONLY IN THE UNITED STATES. THIS WARRANTY GIVES YOU SPECIFIC LEGAL RIGHTS, HOWEVER, YOU MAY HAVE OTHER RIGHTS WHICH MAY VARY FROM STATE TO STATE. SOME STATES DO NOT ALLOW LIMITATIONS ON IMPLIED WARRANTIES OR EXCLUSION OF CONSEQUENTIAL DAMAGE, THEREFORE THESE RESTRICTIONS MAY NOT APPLY TO YOU.

Memo

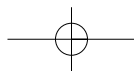
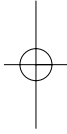
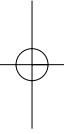



Memorex is an ENERGY STAR® Partner and determines that this, and like similar models, comply with the Energy Star® guidelines for a more energy efficient product.

ENERGY STAR® is a U.S. registered mark.



Covered under one or more of the following U.S. patents:

4,511,761	4,523,058	4,595,795	4,797,916	5,381,460	5,426,690
5,434,905	5,491,745	5,533,010	5,543,605	5,574,727	5,581,598
5,650,790	5,660,269	5,661,780	5,663,981	5,671,248	5,696,471
5,717,312	5,732,355	5,754,407	5,758,289	5,768,345	5,787,356
5,794,152	5,801,466	5,825,161	5,838,721	5,864,619	5,893,034
5,912,968	5,915,227	5,929,598	5,930,720	5,960,358	5,987,330
6,044,281	6,070,082	6,125,277	6,253,088		